

pompa unidirezionale - serie XV

XV-2P

POMPA UNIFICAZIONE TEDESCA
BASE ø80 - ALBERO CONICO



X 2 P 51 42 F S R A

Serie	X	serie XV
Gruppo	2	gruppo 2
Categoria	P	pompa unidirezionale
Cilindrata	51	17
Base	42	Ø80 UNIFICAZIONE TEDESCA rotazione destra (con OR)
Albero	F	CO002 - Conico 1:5 - ø17.4 - M12x1.5 - linguetta sp.3
Corpo	IN	aspirazione - Ø40 a 45° Ø20 M6
	OUT	mandata - Ø35 a 45° Ø15 M6
Coperchio	A	standard

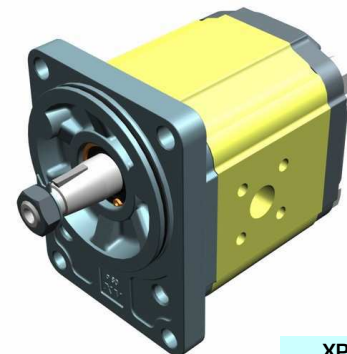

XP217

Tabella dati tecnici

TIPO	Cilindrata cm ³ /giro	Pressione Max.		CODICE																	
		P1 bar	P3 bar	Rotazione Sinistra				Rotazione destra													
XV-2P/04	4,20	260	300	X	2	P	41	41	F	S	R	A	X	2	P	41	42	F	S	R	A
XV-2P/06	6,00	260	300	X	2	P	43	41	F	S	R	A	X	2	P	43	42	F	S	R	A
XV-2P/09	8,40	260	300	X	2	P	45	41	F	S	R	A	X	2	P	45	42	F	S	R	A
XV-2P/11	10,80	260	300	X	2	P	47	41	F	S	R	A	X	2	P	47	42	F	S	R	A
XV-2P/14	14,40	250	290	X	2	P	49	41	F	S	R	A	X	2	P	49	42	F	S	R	A
XV-2P/17	16,80	230	270	X	2	P	51	41	F	S	R	A	X	2	P	51	42	F	S	R	A
XV-2P/19	19,20	210	250	X	2	P	53	41	F	S	R	A	X	2	P	53	42	F	S	R	A
XV-2P/22	22,80	200	240	X	2	P	55	41	F	S	R	A	X	2	P	55	42	F	S	R	A
XV-2P/26	26,20	170	210	X	2	P	57	41	F	S	R	A	X	2	P	57	42	F	S	R	A
XV-2P/30	30,00	160	200	X	2	P	59	41	F	S	S	A	X	2	P	59	42	F	S	S	A
XV-2P/34	34,20	150	190	X	2	P	61	41	F	S	S	A	X	2	P	61	42	F	S	S	A
XV-2P/40	39,60	140	180	X	2	P	63	41	F	S	S	A	X	2	P	63	42	F	S	S	A

P1) Pressione max. di esercizio - P3) Pressione max. di picco

Per applicazioni gravose si consiglia di verificare la coppia ammissibile dell'albero

Tabella dimensioni

TIPO	Peso kg	A	B	C	D	E	F	D	E	F
		mm	mm	mm	IN			OUT		
XV-2P/04	2,330	89,7	41,1	79,7	ø20	40	M6x1	ø15	35	M6x1
XV-2P/06	2,430	92,7	41,1	82,7	ø20	40	M6x2	ø15	35	M6x1
XV-2P/09	2,530	96,7	43,1	86,7	ø20	40	M6x3	ø15	35	M6x1
XV-2P/11	2,630	100,7	47,5	90,7	ø20	40	M6x4	ø15	35	M6x1
XV-2P/14	2,730	106,7	47,5	96,7	ø20	40	M6x5	ø15	35	M6x1
XV-2P/17	2,830	110,7	47,5	100,7	ø20	40	M6x6	ø15	35	M6x1
XV-2P/19	2,930	114,7	47,5	104,7	ø20	40	M6x7	ø15	35	M6x1
XV-2P/22	3,180	120,7	55,0	110,7	ø20	40	M6x8	ø15	35	M6x1
XV-2P/26	3,280	124,7	55,0	114,7	ø20	40	M6x9	ø15	35	M6x1
XV-2P/30	3,530	132,7	63,2	122,7	ø20	40	M6x10	ø20	40	M6x1
XV-2P/34	3,730	139,7	63,2	129,7	ø20	40	M6x11	ø20	40	M6x1
XV-2P/40	3,930	148,7	63,2	138,7	ø20	40	M6x12	ø20	40	M6x1

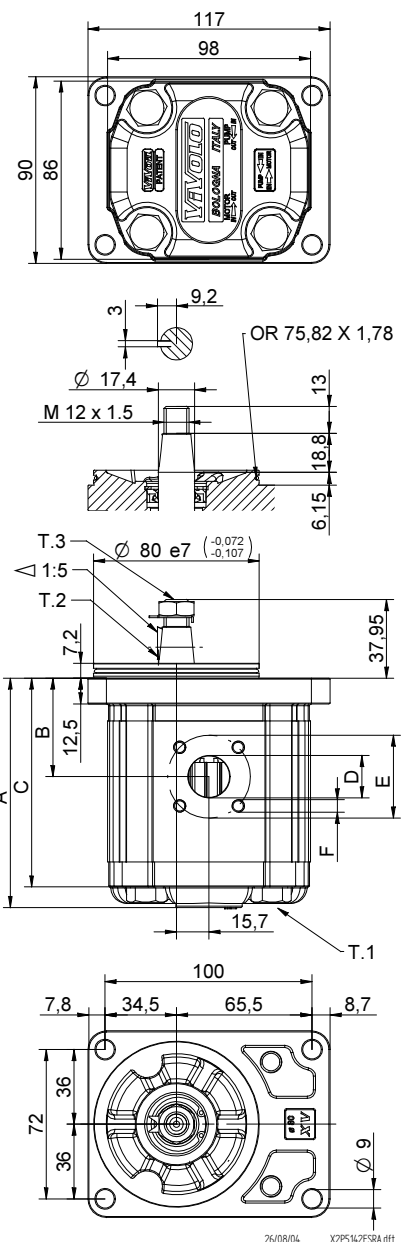

T.1 = 54÷58.9 [Nm] - coppia di serraggio viti M10

T.3 = 40 [Nm] - coppia di serraggio - chiave 19

T.2 = 233.2 [Nm] - coppia ammissibile dell'albero (N.B. Per la scelta dell'albero verificare sempre la coppia ammissibile).

Tavola delle varianti

XV-2P

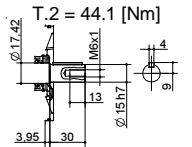
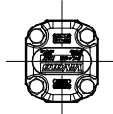
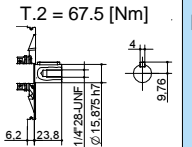
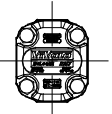
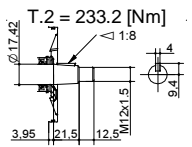
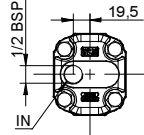
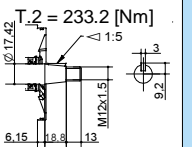
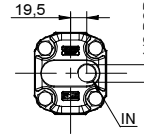
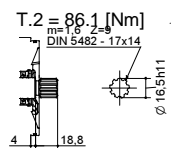
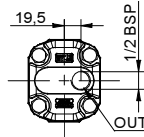
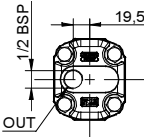
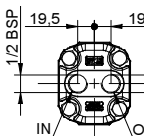
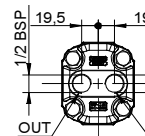
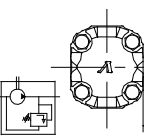
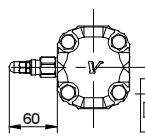
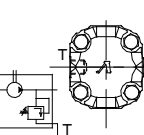
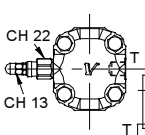

BASE ø80 unificazione tedesca

BASE ø80 unificazione tedesca		Albero		Coperchio	
Rotazione Sinistra	Rotazione destra			Rotazione Sinistra	Rotazione destra
	41		A		A
			B		A
			E		B
			F		B
			H		C
					C
					D
					D
					N
					N
					O
					O

Cilindrata	
TIPO	CODICE
XV-2P/04	41
XV-2P/06	43
XV-2P/09	45
XV-2P/11	47
XV-2P/14	49
XV-2P/17	51
XV-2P/19	53
XV-2P/22	55
XV-2P/26	57
XV-2P/30	59
XV-2P/34	61
XV-2P/40	63

Corpi standard						
Cilindrata	cm3/giro	Filettature standard				
		O - O	S - R	B - B	L - M	Z - Z
4		O - O	S - R	B - B	L - M	Z - Z
6		O - O	S - R	B - B	L - M	Z - Z
9		O - O	S - R	B - B	L - M	Z - Z
11		O - O	S - R	B - B	L - M	Z - Z
14		P - O	S - R	C - B	L - M	Z - Z
17		P - O	S - R	C - B	L - M	Z - Z
19		P - O	S - R	C - B	L - M	Z - Z
22		P - O	S - R	C - B	L - M	Z - Z
26		Q - P	S - R	D - C	L - M	Z - Z
30		Q - P	S - S	D - C	L - M	Z - Z
34		Q - P	S - S	D - C	L - M	Z - Z
40		Q - P	S - S	D - C	L - M	Z - Z

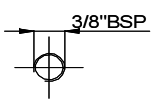
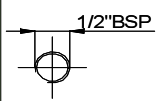
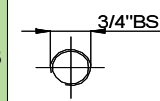
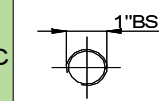
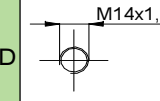
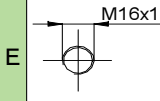
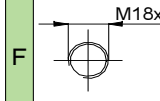
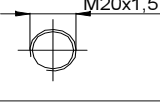
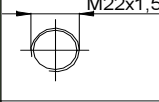
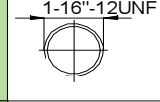
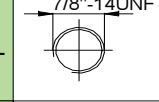
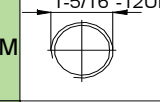
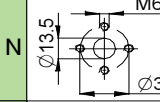
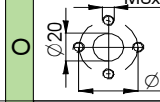
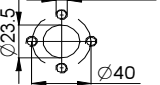
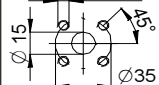
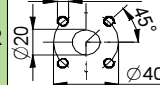
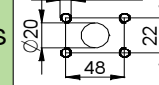
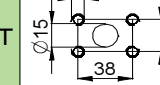
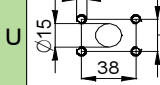
Tabella con indicate le combinazioni delle flangiature e filettature standard disponibili a magazzino

Corpo (filettature e flangiature)													
	A		B		C		D		E		F		G
	H		I		L		M		N		O		P
	Q		R		S		T		U		V		Z