

motore reversibile - serie XV

XV-3M

MOTORE TIPO ""SAE B""
BASE ø101.6 - ALBERO SCANALATO

X 3 M 78 31 I O O E

Serie	X	serie XV
Gruppo	3	gruppo 3
Categoria	M	motore reversibile
Cilindrata	78	38
Base	31	Ø101.6 SAE B rotazione reversibile
Albero	I	SCF04 - Scanalato ø21.81 z=13, H=33.55 SAE J498-13T -16/32DP (SAE B)
Corpo	IN	aspirazione - SAE 30,18 X 58,72 - ø32 - 7/16-14UNC-2B
	OUT	mandata - SAE 30,18 X 58,72 - ø32 - 7/16-14UNC-2B
Coperchio	E	con drenaggio esterno

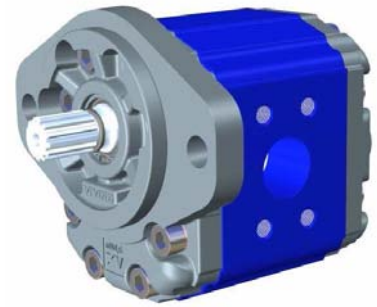

XM332

Tabella dati tecnici

TIPO	Cilindrata cm ³ /giro	Pressione Max.		CODICE	
		P1 bar	P3 bar	Drenaggio esterno	Drenaggio interno
XV-3M/15	14,89	250	270	X 3 M 66 31 I N N E	X 3 M 66 31 I N N F
XV-3M/18	17,37	250	270	X 3 M 68 31 I N N E	X 3 M 68 31 I N N F
XV-3M/21	21,10	250	270	X 3 M 70 31 I N N E	X 3 M 70 31 I N N F
XV-3M/27	26,97	250	270	X 3 M 72 31 I N N E	X 3 M 72 31 I N N F
XV-3M/32	32,27	250	270	X 3 M 74 31 I O O E	X 3 M 74 31 I O O F
XV-3M/38	38,47	250	270	X 3 M 78 31 I O O E	X 3 M 78 31 I O O F
XV-3M/43	43,44	250	270	X 3 M 79 31 I O O E	X 3 M 79 31 I O O F
XV-3M/47	47,16	230	250	X 3 M 80 31 I O O E	X 3 M 80 31 I O O F
XV-3M/51	50,88	230	250	X 3 M 81 31 I O O E	X 3 M 81 31 I O O F
XV-3M/54	54,60	230	250	X 3 M 82 31 I O O E	X 3 M 82 31 I O O F
XV-3M/61	60,81	230	250	X 3 M 83 31 I P P E	X 3 M 83 31 I P P F
XV-3M/64	64,53	210	230	X 3 M 85 31 I P P E	X 3 M 85 31 I P P F
XV-3M/70	70,74	200	220	X 3 M 86 31 I P P E	X 3 M 86 31 I P P F
XV-3M/74	74,46	180	200	X 3 M 87 31 I P P E	X 3 M 87 31 I P P F
XV-3M/90	86,87	150	170	X 3 M 89 31 I P P E	X 3 M 89 31 I P P F

P1) Pressione max. di esercizio - P3) Pressione max. di picco

Per applicazioni gravose si consiglia di verificare la coppia ammissibile dell'albero

Tabella dimensioni

TIPO	Peso	A	B	D	E	F	G
	kg	mm	mm	IN - OUT			
XV-3M/15	7,010	124,0	61,0	ø25	52,37	26,19	3/8-16UNC-2B
XV-3M/18	7,070	126,0	62,0	ø25	52,37	26,19	3/8-16UNC-2B
XV-3M/21	7,150	129,0	63,5	ø25	52,37	26,19	3/8-16UNC-2B
XV-3M/27	7,250	133,0	65,5	ø25	52,37	26,19	3/8-16UNC-2B
XV-3M/32	7,390	138,0	68,0	ø32	58,72	30,18	7/16-14UNC-2B
XV-3M/38	7,520	143,0	70,5	ø32	58,72	30,18	7/16-14UNC-2B
XV-3M/43	7,630	147,0	72,5	ø32	58,72	30,18	7/16-14UNC-2B
XV-3M/47	7,710	150,0	74,0	ø32	58,72	30,18	7/16-14UNC-2B
XV-3M/51	7,790	153,0	75,5	ø32	58,72	30,18	7/16-14UNC-2B
XV-3M/54	7,870	156,0	77,0	ø32	58,72	30,18	7/16-14UNC-2B
XV-3M/61	8,010	161,0	79,5	ø38	69,85	35,71	1/2-13UNC-2B
XV-3M/64	8,090	164,0	81,0	ø38	69,85	35,71	1/2-13UNC-2B
XV-3M/70	8,220	169,0	83,5	ø38	69,85	35,71	1/2-13UNC-2B
XV-3M/74	8,300	172,0	85,0	ø38	69,85	35,71	1/2-13UNC-2B
XV-3M/90	8,570	182,0	90,0	ø38	69,85	35,71	1/2-13UNC-2B

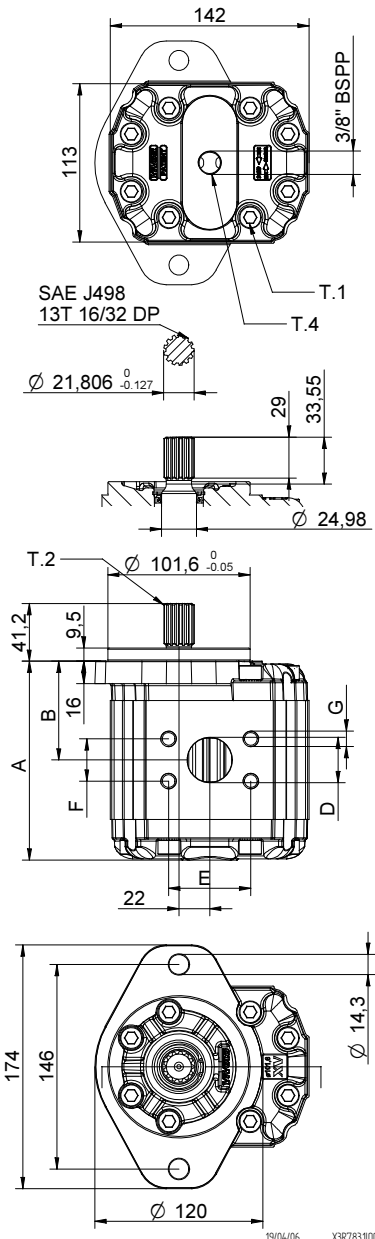

T.1 = 60÷65 [Nm] - coppia di serraggio viti M10

T.2 = 264 [Nm] - coppia ammissibile dell'albero (N.B. Per la scelta dell'albero verificare sempre la coppia ammissibile).

T.4 = 0.3÷0.5 bar - pressione massima drenaggio

BASE $\phi 101.6$

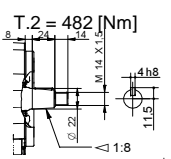
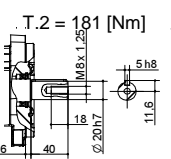
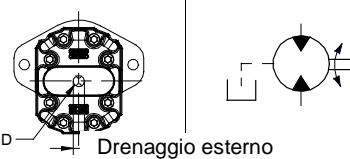
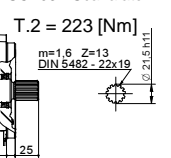
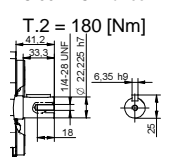
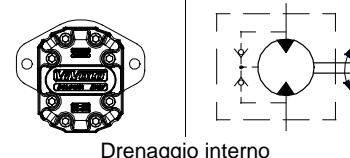
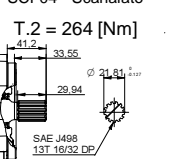
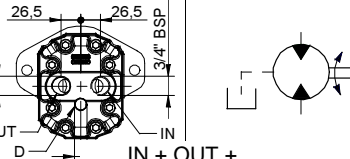
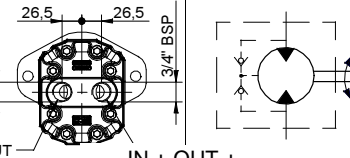
BASE $\phi 101.6$	Albero		Coperchio		
	31				
	CO001 - Conico T.2 = 482 [Nm] 	A	CI001 - Cilindrico T.2 = 181 [Nm] 	E	 Drenaggio esterno
	SCF03 - Scanalato T.2 = 223 [Nm] 	C	CI004 - Cilindrico T.2 = 180 [Nm] 	F	 Drenaggio interno
SCF04 - Scanalato T.2 = 264 [Nm] 	I		K	 IN + OUT +	
			L	 IN + OUT +	

Cilindrata	
TIPO	CODICE
XV-3M/15	66
XV-3M/18	68
XV-3M/21	70
XV-3M/27	72
XV-3M/32	74
XV-3M/38	78
XV-3M/43	79
XV-3M/47	80
XV-3M/51	81
XV-3M/54	82
XV-3M/61	83
XV-3M/64	85
XV-3M/70	86
XV-3M/74	87
XV-3M/90	89

Corpi standard				
Cilindrata	cm3/giro	Filettature standard		
15		A - A	D - D	H - H
18		A - A	D - D	H - H
21		A - A	D - D	H - H
27		A - A	E - E	H - H
32		B - B	E - E	H - H
38		B - B	E - E	H - H
43		B - B	E - E	H - H
47		B - B	E - E	H - H
51		B - B	E - E	H - H
54		B - B	E - E	H - H
61		C - C	F - F	
64		C - C	F - F	
70		C - C	F - F	
74		C - C	F - F	
90		C - C	F - F	

Tabella con indicate le combinazioni delle flangiature e filettature standard disponibili a magazzino

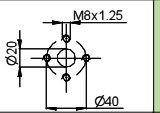
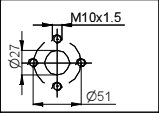
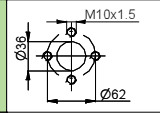
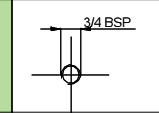
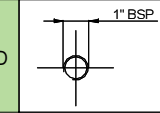
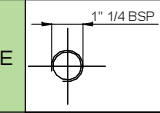
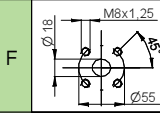
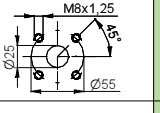
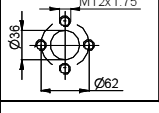
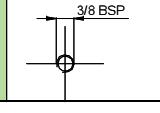
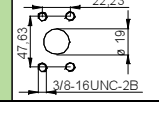
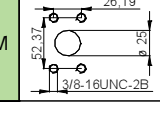
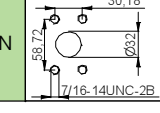
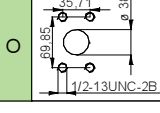
Corpo (filettature e flangiature)													
	A		B		C		D		E		F		G
	H		I		L		M		N		O		P
Corpo Chiuso	Z												