

pompa finale - serie XV

XOF-1

POMPA FINALE ACCOPPIABILE CON XV1
BASE Ø25,4 FEMMINA

X 0 F 06 32 G B B A

Serie	X	serie XV
Gruppo	0	gruppo 0
Categoria	F	pompa finale
Cilindrata	06	0.76
Base	32	Ø25.4 femmina rotazione destra 1P+0P
Albero	G	CI001 - Finale per 1+0, 2+0
Corpo	IN	aspirazione - 1/4" BSP
	OUT	mandata - 1/4" BSP
Coperchio	A	standard

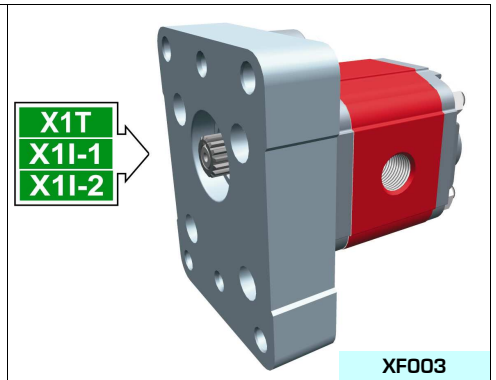

XF003

Tabella dati tecnici

TIPO	Cilindrata cm3/giro	Pressione Max.		CODICE	
		P1 bar	P3 bar	Rotazione Sinistra	Rotazione destra
XOF-1/0.17	0,16	220	260	X 0 F 01 31 G B B A	X 0 F 01 32 G B B A
XOF-1/0.25	0,24	220	260	X 0 F 02 31 G B B A	X 0 F 02 32 G B B A
XOF-1/0.45	0,45	220	280	X 0 F 04 31 G B B A	X 0 F 04 32 G B B A
XOF-1/0.57	0,56	220	280	X 0 F 05 31 G B B A	X 0 F 05 32 G B B A
XOF-1/0.76	0,75	220	280	X 0 F 06 31 G B B A	X 0 F 06 32 G B B A
XOF-1/0.98	0,92	220	280	X 0 F 07 31 G B B A	X 0 F 07 32 G B B A
XOF-1/1.27	1,26	220	280	X 0 F 09 31 G B B A	X 0 F 09 32 G B B A
XOF-1/1.52	1,48	220	280	X 0 F 11 31 G B B A	X 0 F 11 32 G B B A
XOF-1/2.30	2,28	190	210	X 0 F 13 31 G B B A	X 0 F 13 32 G B B A

P1) Pressione max. di esercizio - P3) Pressione max. di picco

Per applicazioni gravose si consiglia di verificare la coppia ammissibile dell'albero

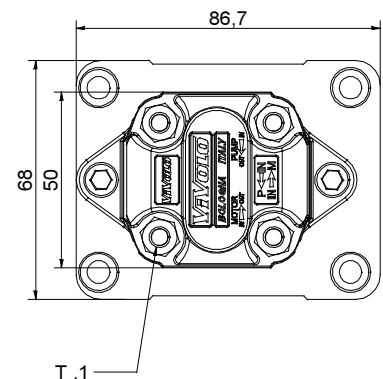

T.1

T.2

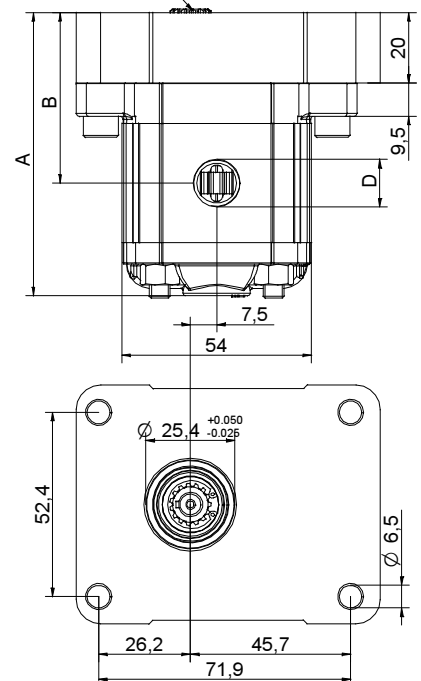

0104/08 XOF06:32GBBA.dft

T.1 = 11.7÷13.7 [Nm] - coppia di serraggio viti M6



T.2 = 2.1 [Nm] - coppia ammissibile dell'albero (N.B. Per la scelta dell'albero verificare sempre la coppia ammissibile).

Tavola delle varianti

XOF-1

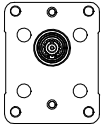
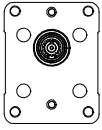
BASE $\varnothing 25,4$ Femmina

BASE $\varnothing 25,4$ Femmina		Albero	
Rotazione Sinistra	Rotazione destra		
	31		32
		CIO01 - Cilindrico T.2 = 2.1 [Nm] $m=0,75$ $Z=15$ $\varnothing 11,8$ h11	G

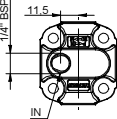
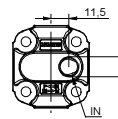
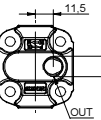
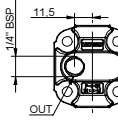
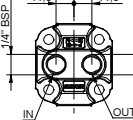
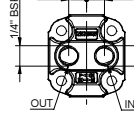
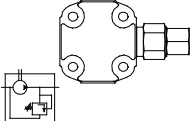
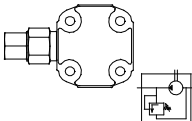
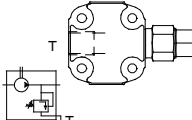
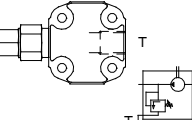
Coperchio		
Rotazione Sinistra	Rotazione destra	
		A
		B
		C
		D
		N Drenaggio interno
		O Drenaggio esterno

Cilindrata	
TIPO	CODICE
XOF-1/0.17	01
XOF-1/0.25	02
XOF-1/0.45	04
XOF-1/0.57	05
XOF-1/0.76	06
XOF-1/0.98	07
XOF-1/1.27	09
XOF-1/1.52	11
XOF-1/2.30	13

Corpi standard				
Cilindrata	cm3/giro	Filettature standard		
		0.17	B - B	Z - B
0.25	B - B	Z - B	Z - Z	
0.45	B - B	Z - B	Z - Z	
0.57	B - B	Z - B	Z - Z	
0.76	B - B	Z - B	Z - Z	
0.98	B - B	Z - B	Z - Z	
1.27	B - B	Z - B	Z - Z	
1.52	B - B	Z - B	Z - Z	
2.30	B - B	Z - B	Z - Z	

Tabella con indicate le combinazioni delle flangiate e filettature standard disponibili a magazzino

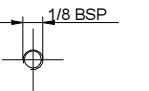
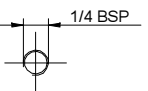
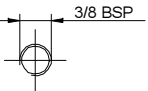
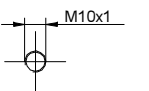
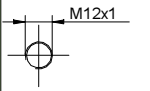
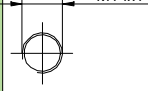
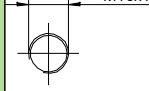
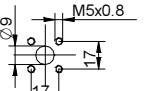
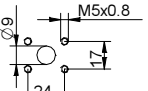
Corpo (filettature e flangiate)													
	A		B		C		D		E		F		G
	H		I	Corpo Chiuso		Z							