

pompa finale - serie XV

POMPA FINALE STANDARD
BASE Ø22 FEMMINA

XOF-0

X 0 F 06 22 N B B A

| | | |
|------------|-----|--|
| Serie | X | serie XV |
| Gruppo | 0 | gruppo 0 |
| Categoria | F | pompa finale |
| Cilindrata | 06 | 0.76 |
| Base | 22 | Ø22 femmina rotazione destra 0P+0P |
| Albero | N | CFF01 - Finale - Codolo fresato ø7.16 - sp.3 |
| Corpo | IN | aspirazione - 1/4" BSP |
| | OUT | mandata - 1/4" BSP |
| Coperchio | A | standard |

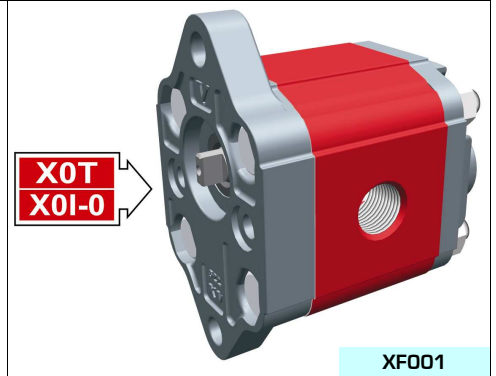

| Tabella dati tecnici | | | | | | |
|----------------------|------------|----------------|--------|---------------------|---------------------|------------------|
| TIPO | Cilindrata | Pressione Max. | | CODICE | | |
| | | cm3/giro | P1 bar | P3 bar | Rotazione Sinistra | Rotazione destra |
| X0F-0/0.17 | 0,16 | 220 | 260 | X 0 F 01 21 N B B A | X 0 F 01 22 N B B A | |
| X0F-0/0.25 | 0,24 | 220 | 260 | X 0 F 02 21 N B B A | X 0 F 02 22 N B B A | |
| X0F-0/0.45 | 0,45 | 220 | 280 | X 0 F 04 21 N B B A | X 0 F 04 22 N B B A | |
| X0F-0/0.57 | 0,56 | 220 | 280 | X 0 F 05 21 N B B A | X 0 F 05 22 N B B A | |
| X0F-0/0.76 | 0,75 | 220 | 280 | X 0 F 06 21 N B B A | X 0 F 06 22 N B B A | |
| X0F-0/0.98 | 0,92 | 220 | 280 | X 0 F 07 21 N B B A | X 0 F 07 22 N B B A | |
| X0F-0/1.27 | 1,26 | 220 | 280 | X 0 F 09 21 N B B A | X 0 F 09 22 N B B A | |
| X0F-0/1.52 | 1,48 | 220 | 280 | X 0 F 11 21 N B B A | X 0 F 11 22 N B B A | |
| X0F-0/2.30 | 2,28 | 190 | 210 | X 0 F 13 21 N B B A | X 0 F 13 22 N B B A | |

P1) Pressione max. di esercizio - P3) Pressione max. di picco

Per applicazioni gravose si consiglia di verificare la coppia ammissibile dell'albero

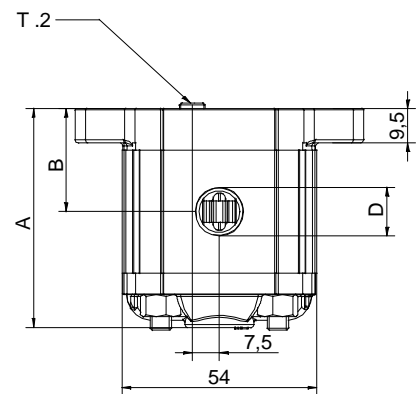
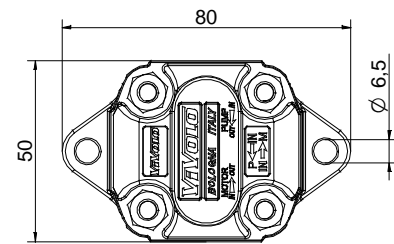

| Tabella dimensioni | | | | | |
|--------------------|-------|------|------|-----------|-----------|
| TIPO | Peso | A | B | D | D |
| | kg | mm | mm | IN | OUT |
| X0F-0/0.17 | 0,400 | 55,8 | 26,2 | 1/4" BSPP | 1/4" BSPP |
| X0F-0/0.25 | 0,410 | 56,4 | 26,5 | 1/4" BSPP | 1/4" BSPP |
| X0F-0/0.45 | 0,420 | 58,0 | 27,3 | 1/4" BSPP | 1/4" BSPP |
| X0F-0/0.57 | 0,430 | 59,0 | 27,8 | 1/4" BSPP | 1/4" BSPP |
| X0F-0/0.76 | 0,440 | 60,5 | 28,5 | 1/4" BSPP | 1/4" BSPP |
| X0F-0/0.98 | 0,460 | 62,0 | 29,3 | 1/4" BSPP | 1/4" BSPP |
| X0F-0/1.27 | 0,480 | 64,5 | 30,5 | 1/4" BSPP | 1/4" BSPP |
| X0F-0/1.52 | 0,500 | 66,5 | 31,5 | 1/4" BSPP | 1/4" BSPP |
| X0F-0/2.30 | 0,560 | 72,5 | 34,5 | 1/4" BSPP | 1/4" BSPP |

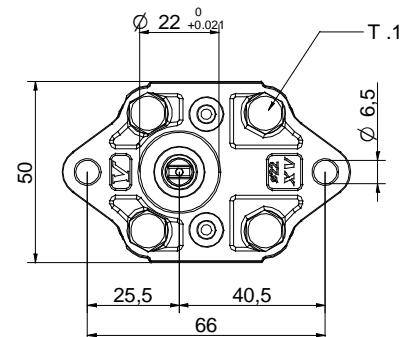

01/04/08 X0F0622NBA.dft



T.1 = 11.7÷13.7 [Nm] - coppia di serraggio viti M6



T.2 = 3.7 [Nm] - coppia ammissibile dell'albero (N.B. Per la scelta dell'albero verificare sempre la coppia ammissibile).

Tavola delle varianti

XOF-O

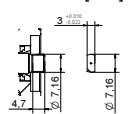
BASE ø22 Femmina Standard

| BASE ø22 Femmina Standard | | Albero | |
|---|------------------|---|----|
| Rotazione Sinistra | Rotazione destra | | |
|  | 21 |  | 22 |
| | | CFF01 - Codolo fresato T.2 = 3.7 [Nm] | N |
| | |  | |

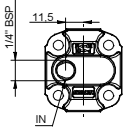
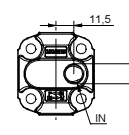
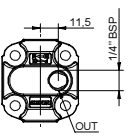
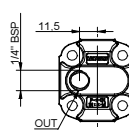
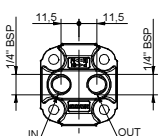
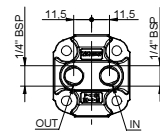
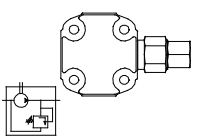
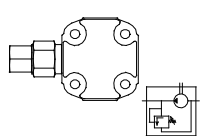
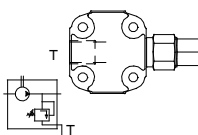
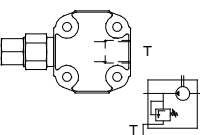
| Coperchio | | |
|---|---|------------------------|
| Rotazione Sinistra | Rotazione destra | |
|  |  | A |
|  |  | B |
|  |  | C |
|  |  | D |
|  |  | N Drenaggio interno |
|  |  | O Drenaggio esterno |

| Cilindrata | |
|------------|--------|
| TIPO | CODICE |
| XOF-0/0.17 | 01 |
| XOF-0/0.25 | 02 |
| XOF-0/0.45 | 04 |
| XOF-0/0.57 | 05 |
| XOF-0/0.76 | 06 |
| XOF-0/0.98 | 07 |
| XOF-0/1.27 | 09 |
| XOF-0/1.52 | 11 |
| XOF-0/2.30 | 13 |

| Corpi standard | | | | |
|----------------|----------|----------------------|-------|-------|
| Cilindrata | cm3/giro | Filettature standard | | |
| | | B - B | Z - B | Z - Z |
| 0.17 | | B - B | Z - B | Z - Z |
| 0.25 | | B - B | Z - B | Z - Z |
| 0.45 | | B - B | Z - B | Z - Z |
| 0.57 | | B - B | Z - B | Z - Z |
| 0.76 | | B - B | Z - B | Z - Z |
| 0.98 | | B - B | Z - B | Z - Z |
| 1.27 | | B - B | Z - B | Z - Z |
| 1.52 | | B - B | Z - B | Z - Z |
| 2.30 | | B - B | Z - B | Z - Z |

Tabella con indicate le combinazioni delle flangiate e filettature standard disponibili a magazzino

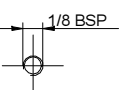
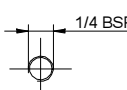
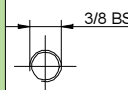
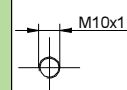
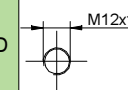
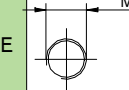
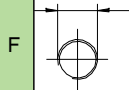
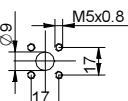
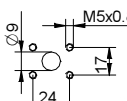
| Corpo (filettature e flangiate) | | | | | | | | | | | | | |
|---|---|---|---|---|---|---|---|---|---|---|---|---|---|
|  | A |  | B |  | C |  | D |  | E |  | F |  | G |
|  | H |  | I | Corpo Chiuso | | Z | | | | | | | |