

motore reversibile - serie XV

XV-3M

MOTORE STANDARD EUROPEO
BASE ø50.8 - ALBERO CONICO

X 3 M 78 01 A E E E

Serie	X	serie XV
Gruppo	3	gruppo 3
Categoria	M	motore reversibile
Cilindrata	78	38
Base	01	Ø50.8 rotazione reversibile
Albero	A	CO001 - Conico 1:8 - ø22 - linguetta sp.4
Corpo	IN	aspirazione - 1" BSP
	OUT	mandata - 1" BSP
Coperchio	E	con drenaggio esterno

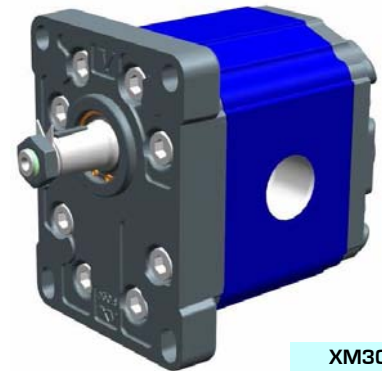

XM302

Tabella dati tecnici

TIPO	Cilindrata	Pressione Max.		CODICE	
		cm3/giro	P1 bar	P3 bar	Drenaggio esterno
XV-3M/15	14,89	250	270	X 3 P 66 01 A D D E	X 3 P 66 02 A D D F
XV-3M/18	17,37	250	270	X 3 P 68 01 A D D E	X 3 P 68 02 A D D F
XV-3M/21	21,10	250	270	X 3 P 70 01 A D D E	X 3 P 70 02 A D D F
XV-3M/27	26,97	250	270	X 3 P 72 01 A E E E	X 3 P 72 02 A E E F
XV-3M/32	32,27	250	270	X 3 P 74 01 A E E E	X 3 P 74 02 A E E F
XV-3M/38	38,47	250	270	X 3 P 78 01 A E E E	X 3 P 78 02 A E E F
XV-3M/43	43,44	250	270	X 3 P 79 01 A E E E	X 3 P 79 02 A E E F
XV-3M/47	47,16	230	250	X 3 P 80 01 A E E E	X 3 P 80 02 A E E F
XV-3M/51	50,88	230	250	X 3 P 81 01 A E E E	X 3 P 81 02 A E E F
XV-3M/54	54,60	230	250	X 3 P 82 01 A E E E	X 3 P 82 02 A E E F
XV-3M/61	60,81	230	250	X 3 P 83 01 A F F E	X 3 P 83 02 A F F F
XV-3M/64	64,53	210	230	X 3 P 85 01 A F F E	X 3 P 85 02 A F F F
XV-3M/70	70,74	200	220	X 3 P 86 01 A F F E	X 3 P 86 02 A F F F
XV-3M/74	74,46	180	200	X 3 P 87 01 A F F E	X 3 P 87 02 A F F F
XV-3M/90	86,87	150	170	X 3 P 89 01 A F F E	X 3 P 89 02 A F F F

P1) Pressione max. di esercizio - P3) Pressione max. di picco

Per applicazioni gravose si consiglia di verificare la coppia ammissibile dell'albero

Tabella dimensioni

TIPO	Peso	A	B	D	D
	kg	mm	mm	IN	OUT
XV-3M/15	7,010	122,0	61,0	3/4" BSPP	3/4" BSPP
XV-3M/18	7,070	124,0	62,0	3/4" BSPP	3/4" BSPP
XV-3M/21	7,150	127,0	63,5	3/4" BSPP	3/4" BSPP
XV-3M/27	7,250	131,0	65,5	1" BSPP	1" BSPP
XV-3M/32	7,390	136,0	68,0	1" BSPP	1" BSPP
XV-3M/38	7,520	141,0	70,5	1" BSPP	1" BSPP
XV-3M/43	7,630	145,0	72,5	1" BSPP	1" BSPP
XV-3M/47	7,710	148,0	74,0	1" BSPP	1" BSPP
XV-3M/51	7,790	151,0	75,5	1" BSPP	1" BSPP
XV-3M/54	7,870	154,0	77,0	1" BSPP	1" BSPP
XV-3M/61	8,010	159,0	79,5	1" 1/4 BSPP	1" 1/4 BSPP
XV-3M/64	8,090	162,0	81,0	1" 1/4 BSPP	1" 1/4 BSPP
XV-3M/70	8,220	167,0	83,5	1" 1/4 BSPP	1" 1/4 BSPP
XV-3M/74	8,300	170,0	85,0	1" 1/4 BSPP	1" 1/4 BSPP
XV-3M/90	8,570	180,0	90,0	1" 1/4 BSPP	1" 1/4 BSPP

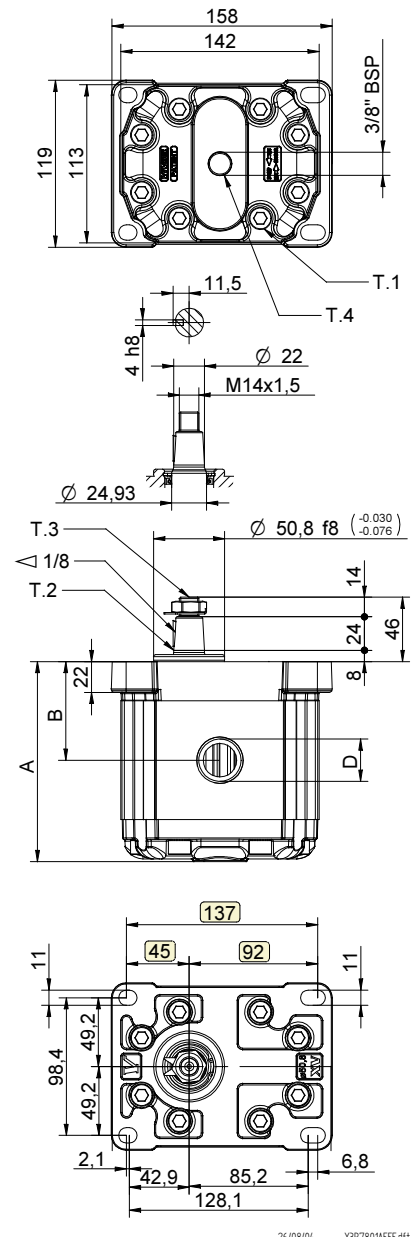



T.1 = 60÷65 [Nm] - coppia di serraggio viti M10

T.3 = 75 [Nm] - coppia di serraggio - chiave 22

T.2 = 482 [Nm] - coppia ammissibile dell'albero (N.B. Per la scelta dell'albero verificare sempre la coppia ammissibile).

T.4 = 0.3÷0.5 bar - pressione massima drenaggio

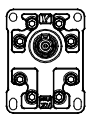
BASE ø50.8

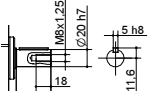
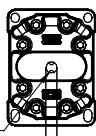
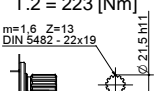
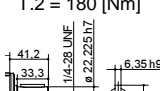
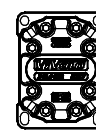
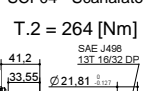
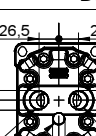
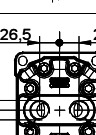
BASE ø50.8	Albero		Coperchio				
	01	CO001 - Conico T.2 = 482 [Nm] 	A	CI001 - Cilindrico T.2 = 181 [Nm] 	B	E	 Drenaggio esterno
		SCF03 - Scanalato T.2 = 223 [Nm] m=1,6 Z=13 DIN 5482 - 22x19 	C	CI004 - Cilindrico T.2 = 180 [Nm] 	H	F	 Drenaggio interno
		SCF04 - Scanalato T.2 = 264 [Nm] SAE J498 13T 18/32 DP 	I			K	 IN + OUT +
						L	 IN + OUT +

Cilindrata	
TIPO	CODICE
XV-3M/15	66
XV-3M/18	68
XV-3M/21	70
XV-3M/27	72
XV-3M/32	74
XV-3M/38	78
XV-3M/43	79
XV-3M/47	80
XV-3M/51	81
XV-3M/54	82
XV-3M/61	83
XV-3M/64	85
XV-3M/70	86
XV-3M/74	87
XV-3M/90	89

Corpi standard				
Cilindrata	cm3/giro	Filettature standard		
15		A - A	D - D	H - H
18		A - A	D - D	H - H
21		A - A	D - D	H - H
27		A - A	E - E	H - H
32		B - B	E - E	H - H
38		B - B	E - E	H - H
43		B - B	E - E	H - H
47		B - B	E - E	H - H
51		B - B	E - E	H - H
54		B - B	E - E	H - H
61		C - C	F - F	
64		C - C	F - F	
70		C - C	F - F	
74		C - C	F - F	
90		C - C	F - F	

Tabella con indicate le combinazioni delle flangiature e filettature standard disponibili a magazzino

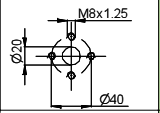
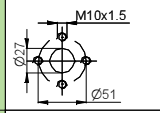
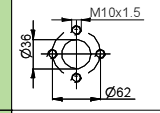
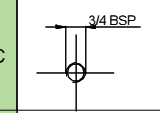
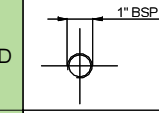
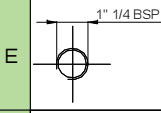
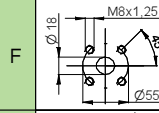
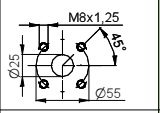
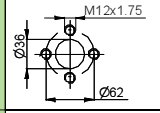
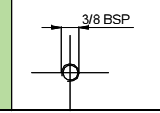
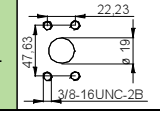
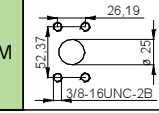
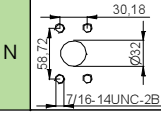
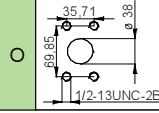
Corpo (filettature e flangiature)													
	A		B		C		D		E		F		G
	H		I		L		M		N		O		P
Corpo Chiuso	Z												